



solutions structure

38 rue de l'Usine
88220 Raon-aux-Bois
03 29 62 62 81
Fax : 03 29 62 60 34
www.vsb.fr

ABRIS JARDIN et TERRASSE COUVERTE

Modèles accolés

1 Pente

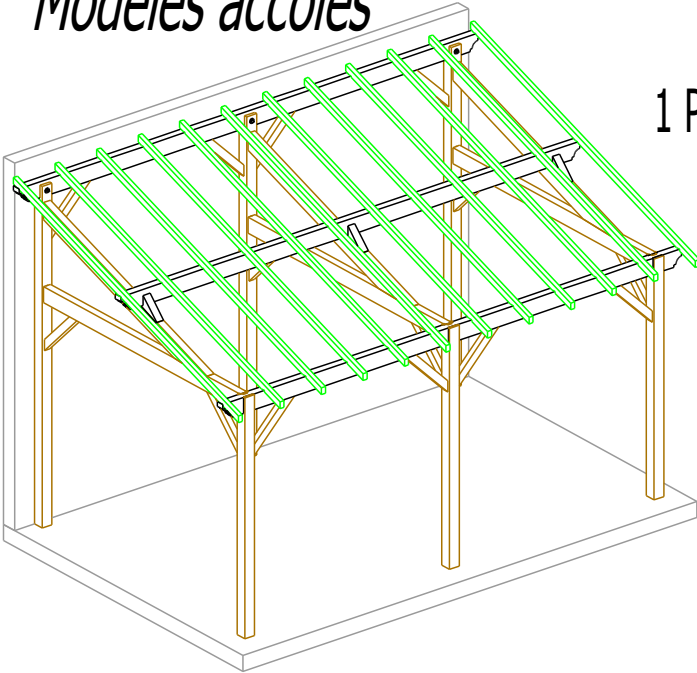

2 Pentés

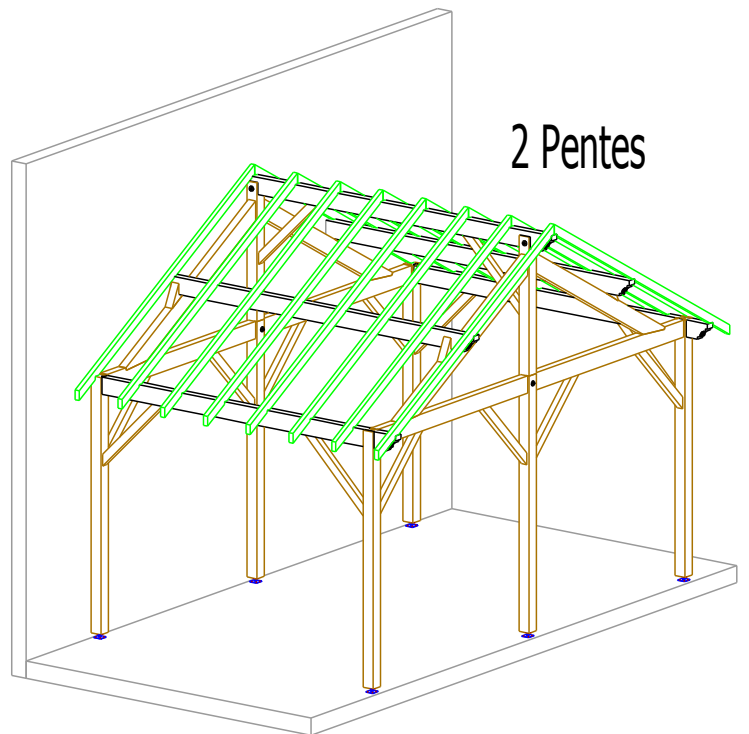

3 Pentés

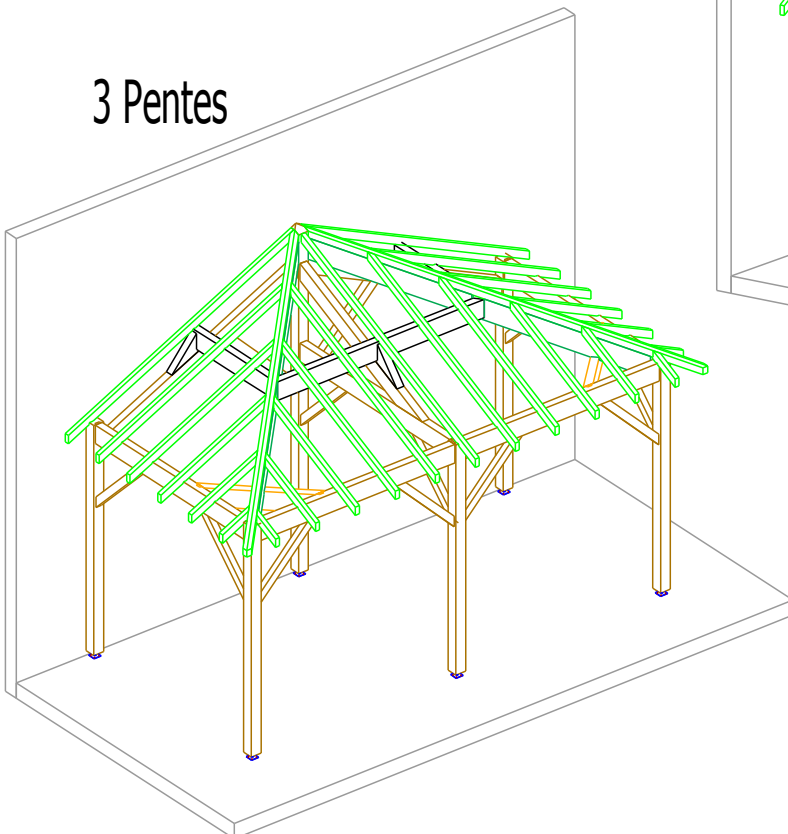



solutions structure

38 rue de l'Usine
88220 Raon-aux-Bois
03 29 62 62 81
Fax : 03 29 62 60 34
www.vsb.fr

ABRIS JARDIN et TERRASSE COUVERTE

Modèles indépendants

2 Pentes

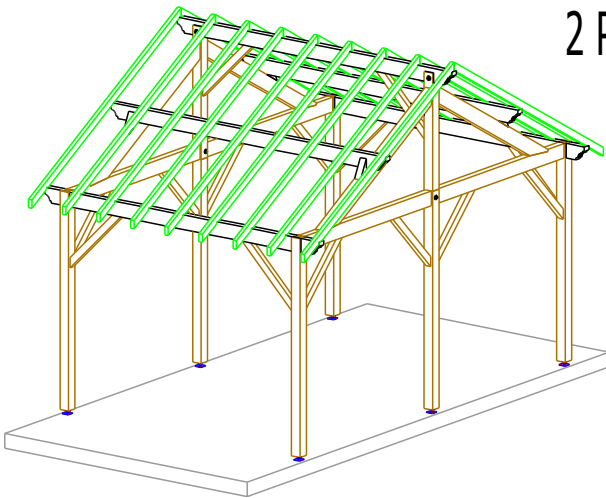

3 Pentes

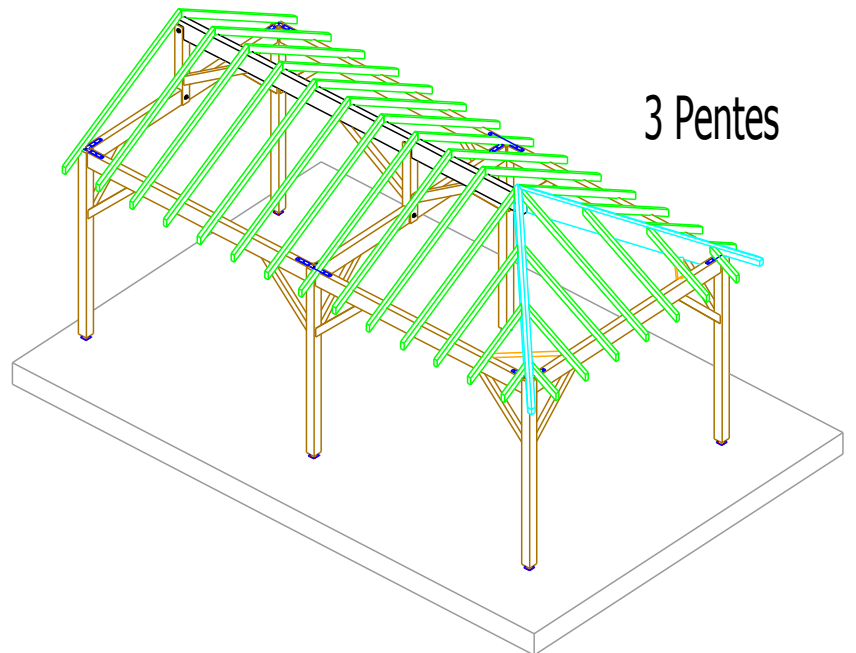

4 Pentes

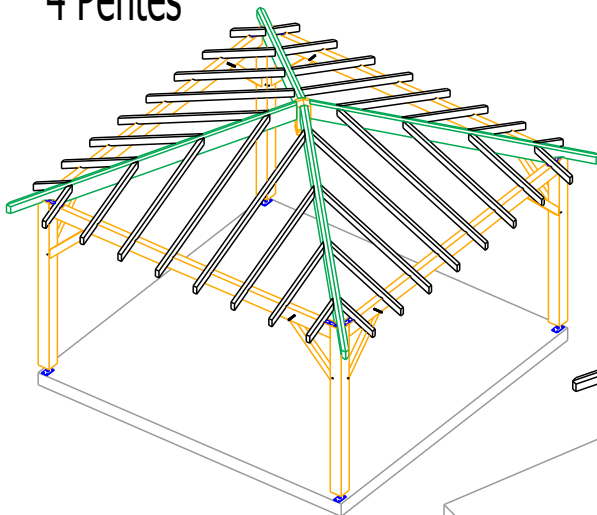

6 Pentes

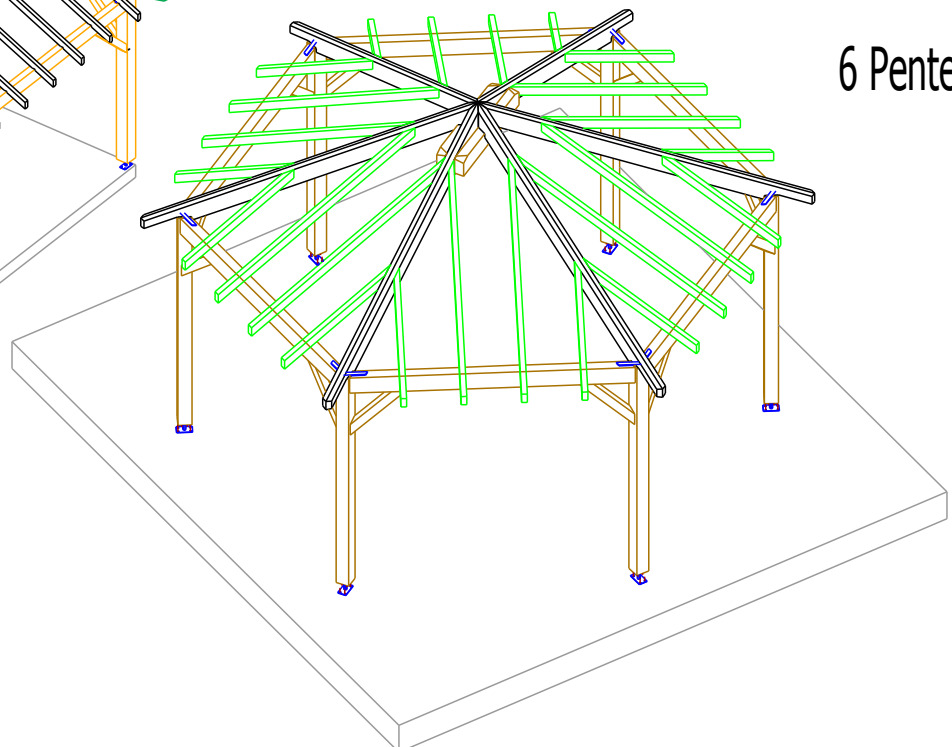



solutions structure

38 rue de l'Usine
88220 Raon-aux-Bois
03 29 62 62 81
Fax : 03 29 62 60 34
www.vsb.fr

Abris jardin et Terrasse couverte - accolés

1 PENTES

Mesures (m)

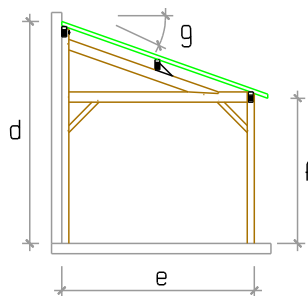
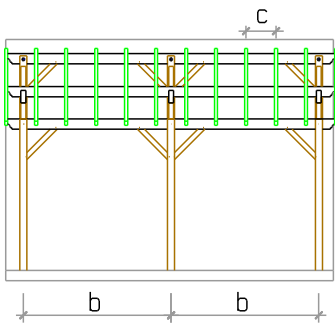
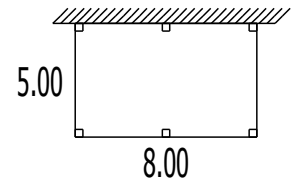
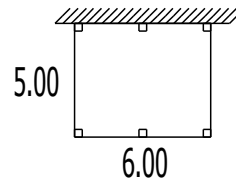
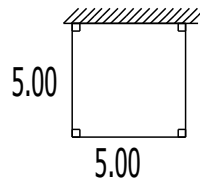
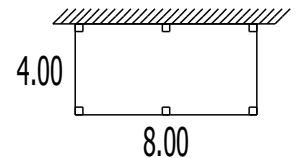
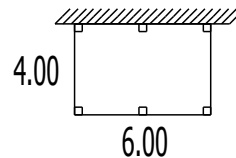
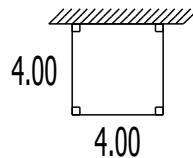
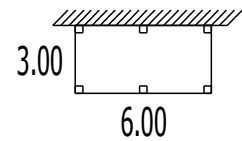
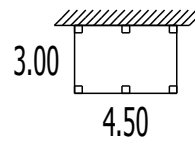
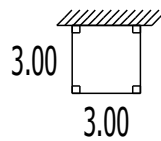

Composant et section (mm)

Bras 78/98
Chevron 58/78
Panne 100/200
Poteau 140/140 contre-collé
Poutre 100/200

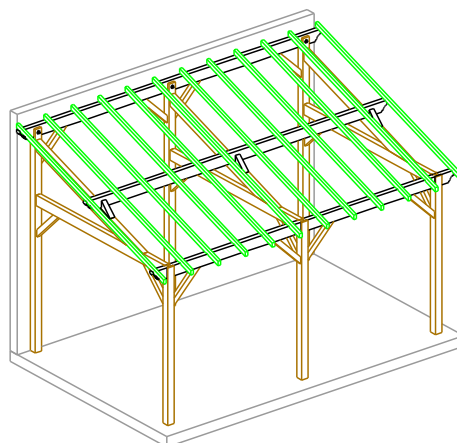
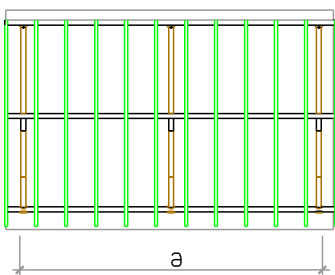

Détail Pied de Poteau

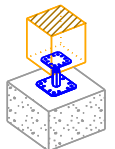

EN OPTION standard

Fermeture des cotés (totale ou partielle)
Plancher bois surélevé (hors sol)
Panneaux de toiture

EN OPTION personnalisée

Murs OB
Portes et fenêtres

ENSEMBLE COMPLET bois massif abouté et contre-collé raboté 4 faces chanfreiné traité classe 3
Non compris: maçonnerie, montage sur site, lasure, couverture, zinguerie



solutions structure

38 rue de l'Usine
88220 Raon-aux-Bois
03 29 62 62 81
Fax : 03 29 62 60 34
www.vsb.fr

Abris jardin et Terrasse couverte - accolés

2 PENTES

Mesures (m)

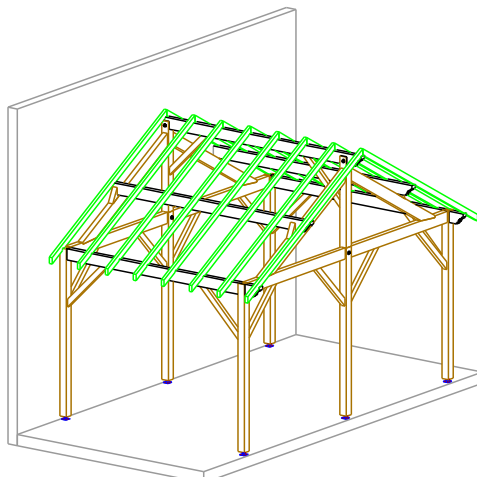
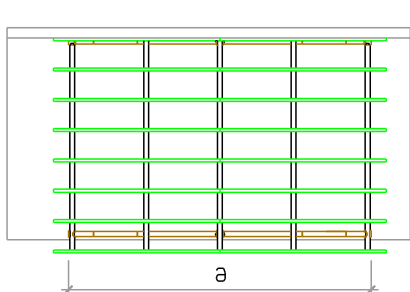
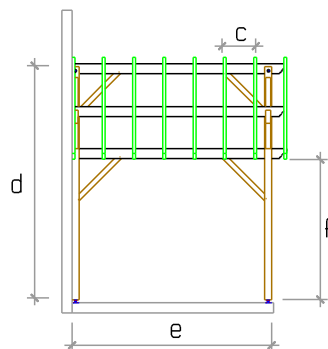
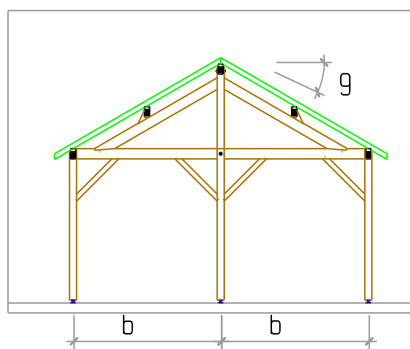
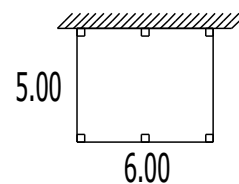
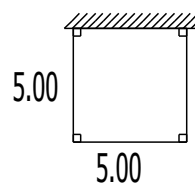
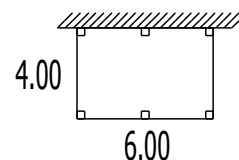
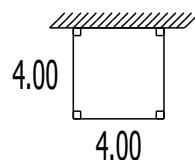
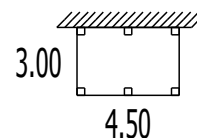
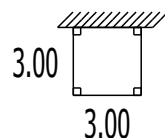

Composant et section (mm)

Bras 78/98
Chevrans 58/98
Pannes 100/200
Poinçon 140/140
Poteau 140/140 contre-collé
Arbalétrier 100/200
Poutre 100/200

Détail Pied de Poteau

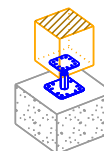

EN OPTION standard

- Fermeture des côtés (totale ou partielle)
- Plancher bois surélevé (hors sol)
- Panneaux de toiture

EN OPTION personnalisée

- Murs OB
- Portes et fenêtres

ENSEMBLE COMPLET bois massif abouté et contre-collé raboté 4 faces chanfreiné traité classe 3

Non compris: maçonnerie, montage sur site, lasure, couverture, zinguerie



solutions structure

38 rue de l'Usine
88220 Raon-aux-Bois
03 29 62 62 81
Fax : 03 29 62 60 34
www.vsb.fr

Abris jardin et Terrasse couverte - accolés

3 PENTES



Mesures (m)

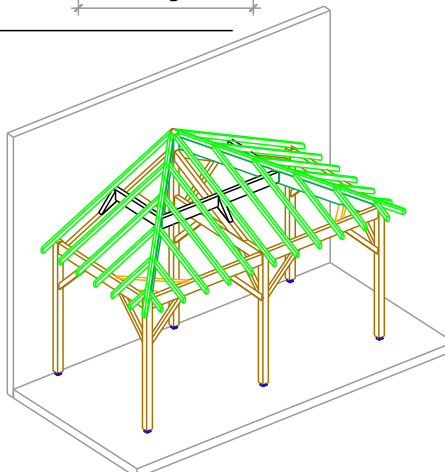
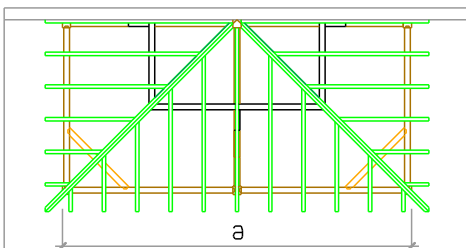
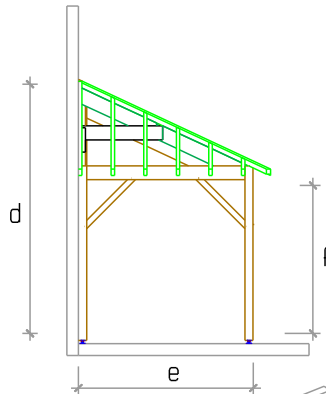
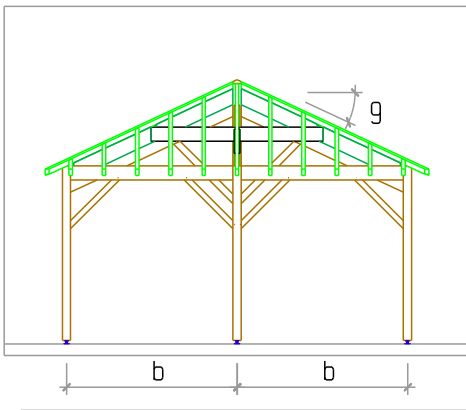
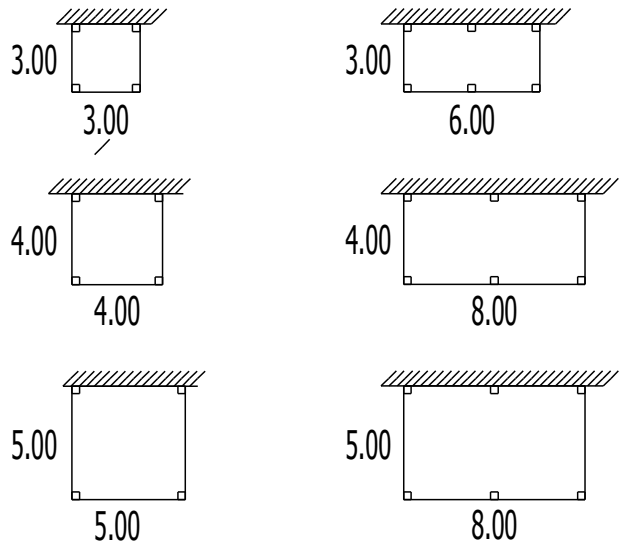

Composant et section (mm)

Bras 78/98
Chevron 58/98
Panne 100/240
Poteau 180/180 contre-collé
Arbalétrier 100/240
Poutre 100/200

Détail Pied de Poteau

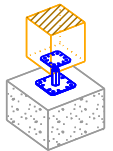

EN OPTION standard

- Fermeture des cotés (totale ou partielle)
- Plancher bois surélevé (hors sol)
- Panneaux de toiture

EN OPTION personnalisée

- Murs OB
- Portes et fenêtres

ENSEMBLE COMPLET bois massif abouté et contre-collé raboté 4 faces chanfreiné traité classe 3

Non compris: maçonnerie, montage sur site, lasure, couverture, zinguerie



solutions structure

38 rue de l'Usine
88220 Raon-aux-Bois
03 29 62 62 81
Fax : 03 29 62 60 34
www.vsb.fr

Abris jardin et Terrasse couverte - indépendants

2 PENTES

Mesures (m)

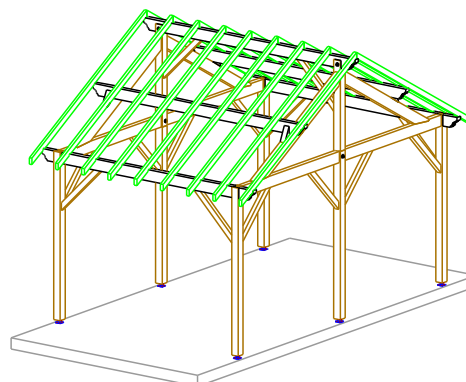
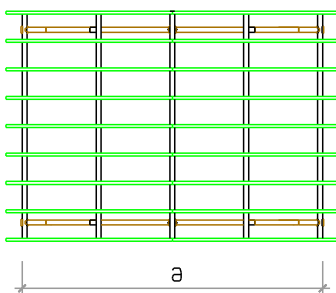
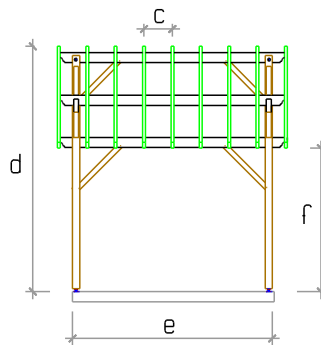
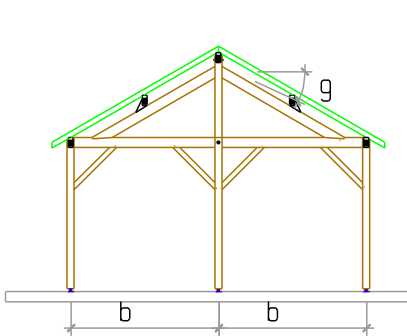
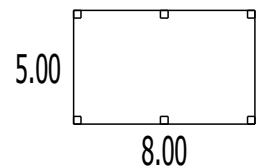
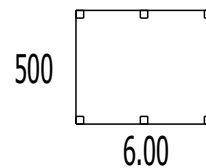
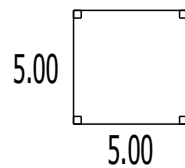
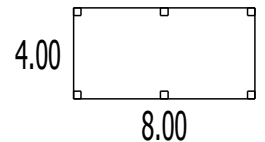
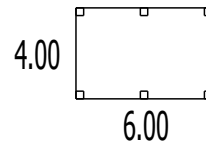
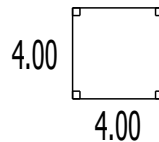
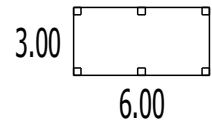
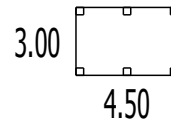
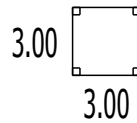

Composant et section (mm)
Bras 78/98
Chevron 58/98
Panne 100/200
Poinçon 140/140
Poteau 140/140 contre-collé
Arbalétrier 100/200
Poutre 100/200

Détail Pied de Poteau

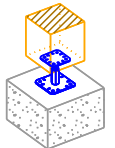

EN OPTION standard

- Fermeture des cotés (totale ou partielle)
- Plancher bois surélevé (hors sol)
- Panneaux de toiture

EN OPTION personnalisée

- Murs OB
- Portes et fenêtres

ENSEMBLE COMPLET bois massif abouté et contre-collé raboté 4 faces chanfreiné traité classe 3
Non compris: maçonnerie, montage sur site, lasure, couverture, zinguerie



solutions structure

38 rue de l'Usine
88220 Raon-aux-Bois
03 29 62 62 81
Fax : 03 29 62 60 34
www.vsb.fr

Abris jardin et Terrasse couverte - indépendants

3 PENTES

Mesures (m)

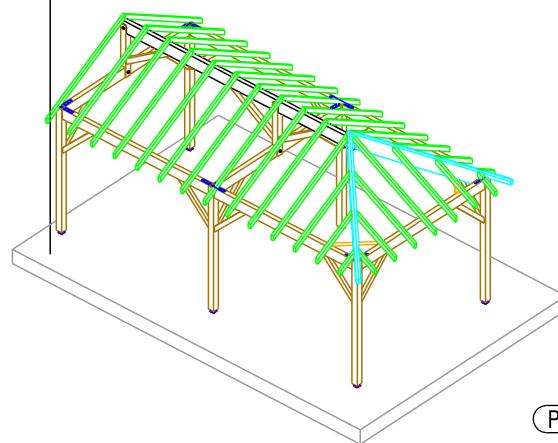
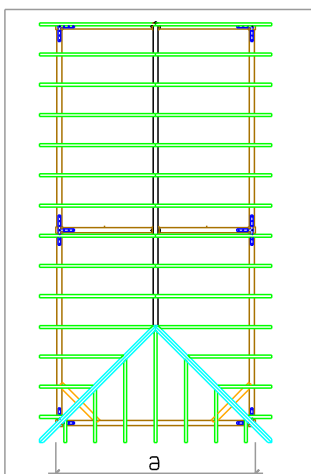
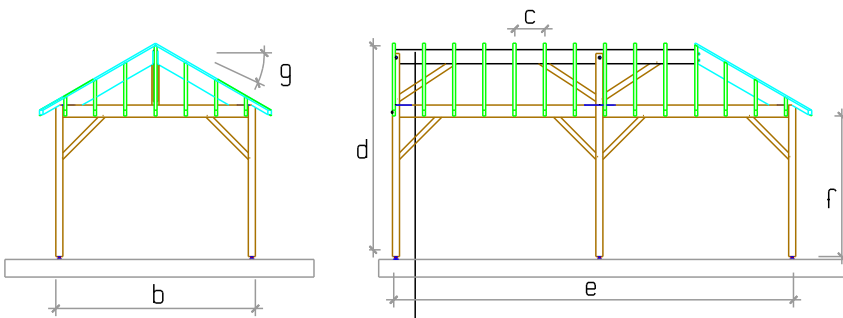
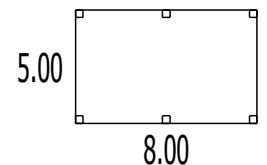
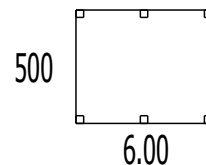
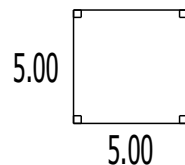
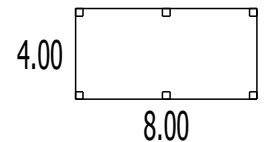
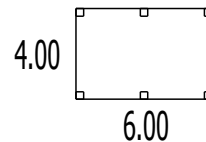
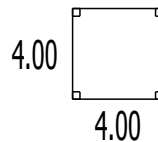
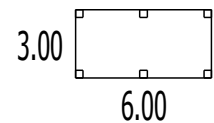
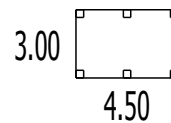
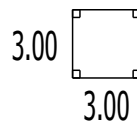

Composant et section (mm)

Bras 78/98
Chevrons 58/98
Pannes 100/200
Poinçon 140/140
Poteau 140/140 contre-collé
Arêtier 100/240
Poutre 100/200

EN OPTION standard

Fermeture des cotés (totale ou partielle)

Plancher bois surélevé (hors sol)

Panneaux de toiture

EN OPTION personnalisée

Murs OB

Portes et fenêtres

Platine de jonction

Détail Pied de Poteau

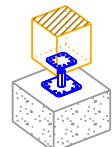
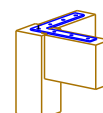

ENSEMBLE COMPLET bois massif abouté et contre-collé raboté 4 faces chanfreiné traité classe 3

Non compris: maçonnerie, montage sur site, lasure, couverture, zinguerie



solutions structure

38 rue de l'Usine
88220 Raon-aux-Bois
03 29 62 62 81
Fax : 03 29 62 60 34
www.vsb.fr

Abris jardin et Terrasse couverte - indépendants

4 PENTES



Mesures (m)

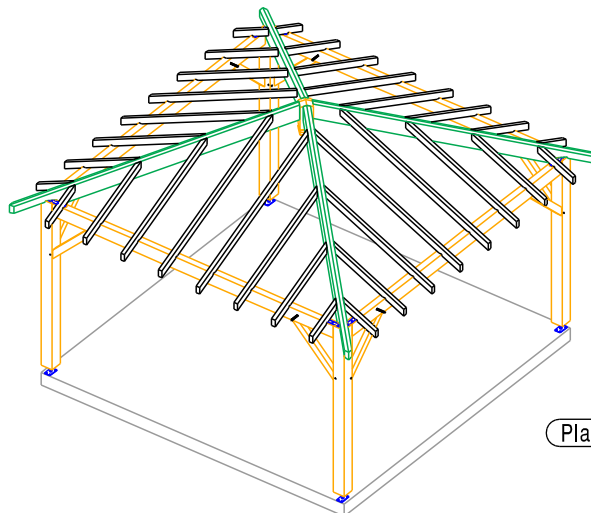
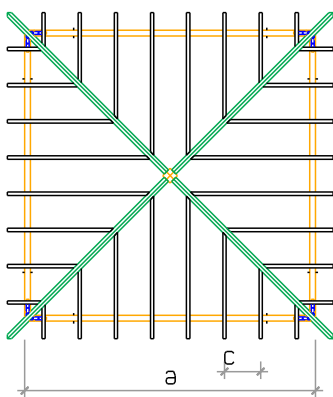
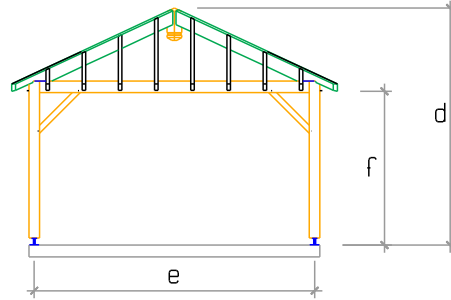
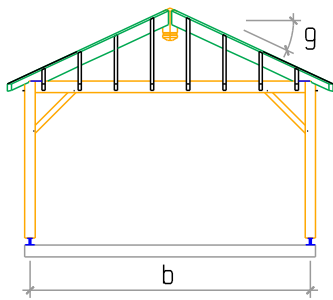
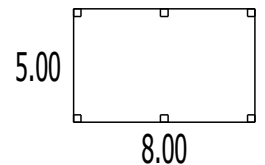
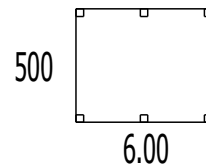
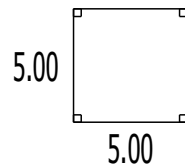
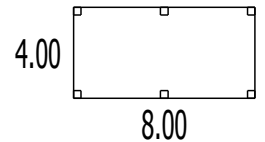
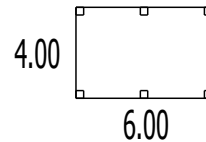
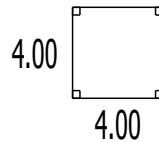
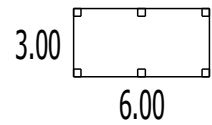
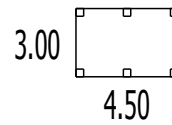
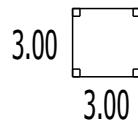

Composant et section (mm)
Bras 78/98
Chevrons 58/98
Pannes 100/200
Poinçon 180/180
Poteau 180/180 contre-collé
Arêtier 100/240
Poutre 100/200

EN OPTION standard
Fermeture des cotés (totale ou partielle)
Plancher bois surélevé (hors sol)
Panneaux de toiture

EN OPTION personnalisée
Murs OB
Portes et fenêtres

Platine de jonction

Détail Pied de Poteau

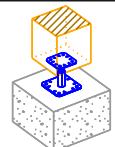
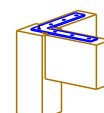

ENSEMBLE COMPLET bois massif aboté et contre-collé raboté 4 faces chanfreiné traité classe 3
Non compris: maçonnerie, montage sur site, lasure, couverture, zinguerie



solutions structure

38 rue de l'Usine
88220 Raon-aux-Bois
03 29 62 62 81
Fax : 03 29 62 60 34
www.vsb.fr

Abris jardin et Terrasse couverte - indépendants

6 PENTES

Mesures (m)

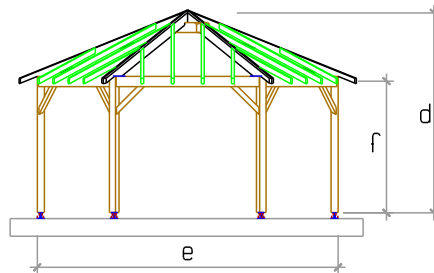
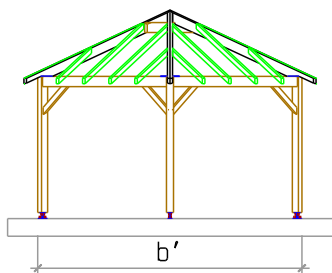
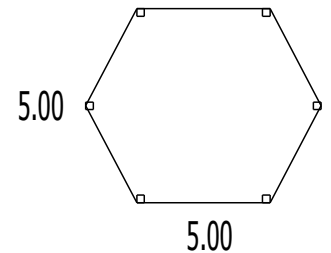
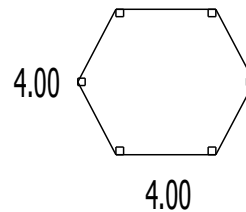
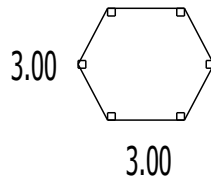

Composant et section (mm)
Bras 78/98
Chevrans 58/98
Pannes 100/200
Poteau 140/140 contre-collé
Arêtier 100/200
Poutre 100/200

EN OPTION standard

- Fermeture des cotés (totale ou partielle)
- Plancher bois surélevé (hors sol)
- Panneaux de toiture

EN OPTION personnalisée

- Murs OB
- Portes et fenêtres

Platine de jonction

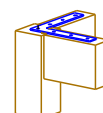

Détail Pied de Poteau

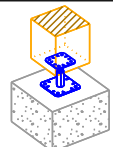

ENSEMBLE COMPLET bois massif abouté et contre-collé raboté 4 faces chanfreiné traité classe 3
Non compris: maçonnerie, montage sur site, lasure, couverture, zinguerie



solutions structure

38 rue de l'Usine
88220 Raon-aux-Bois
03 29 62 62 81
Fax : 03 29 62 60 34
www.vsb.fr

Légende

Détail Pied de Poteau

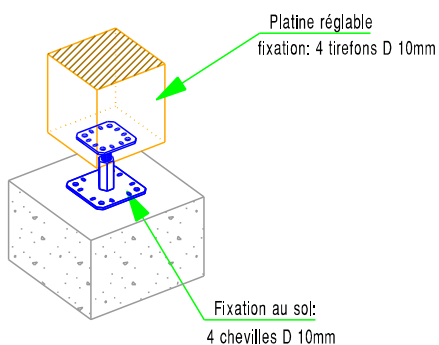

Détail Sabot Métallique

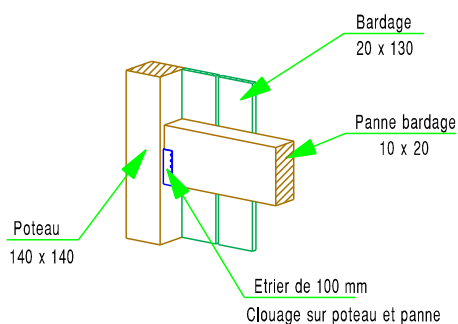

Détail Platine de Jonction

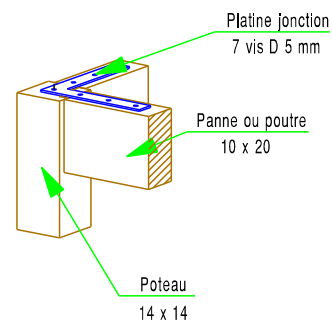

Option structure légère et bardage (20 x 130 autoclave CL3)

Bardage vertical Modèle ouvert ou semi ouvert

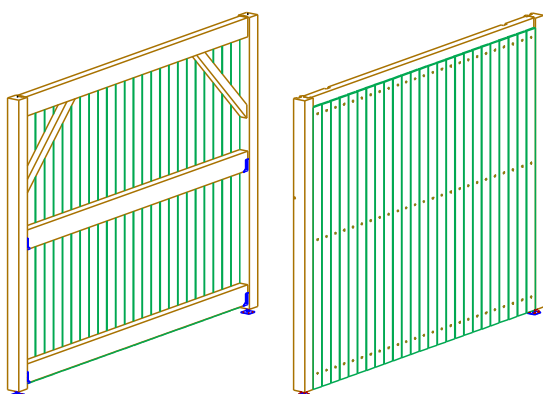

Bardage horizontal Modèle ouvert ou semi ouvert

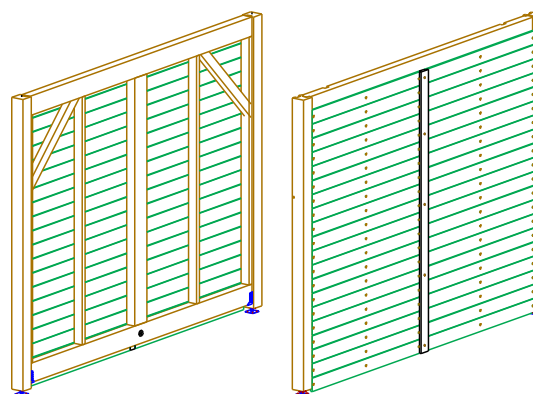

Plancher selon X ou Y

